

# NOVONIX

NOVONIX LIMITED

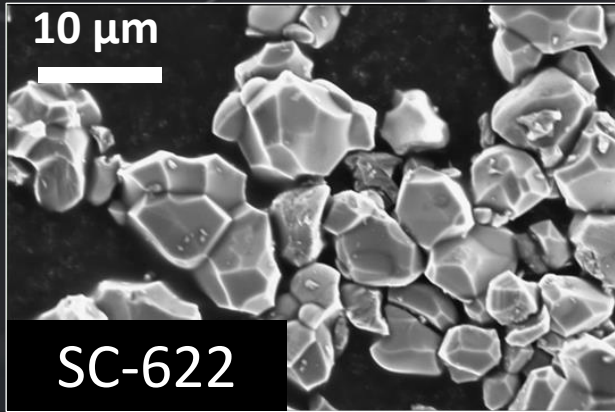
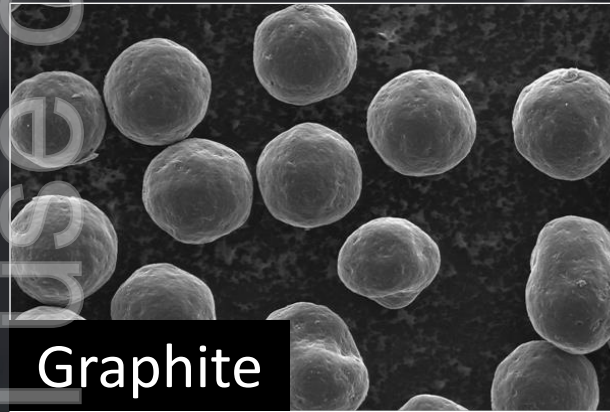

Quarterly Activities Report  
April – June 2021

# Who We Are

*NOVONIX provides battery development and material technology. We develop and supply what we believe to be the most accurate battery testing technology in the world. To our knowledge, we are the only qualified US-based supplier of battery-grade synthetic graphite anode material.*

**NOVONIX**  
*Better Performance, Longer Life, Lower Cost*

*Most Accurate Battery Testing  
Technology*

**NOVONIX**  
Battery Technology Solutions

*Only Qualified US-Based  
Supplier of Synthetic Graphite  
Anode Material*

**NOVONIX**  
Anode Materials

*Developing New Applications  
and Partnerships*

**NOVONIX** |   
Cathode Materials

**NOVONIX**

ASX: NVX

OTCQX: NVNXF

# Contents

- Recap of Recent Notable Milestones
- Quarterly Activities Report (April – June 2021)
  - Corporate Update
  - NOVONIX Anode Materials (NAM) Update
  - Battery Technology Solutions (BTS) Update
  - Cathode/DPMG Update
- Appendix
  - New Additions to the Team
  - NOVONIX Anode Materials Growth Plan
  - ESG and the Importance of Longer Life Batteries

# Recent NOVONIX Announcements

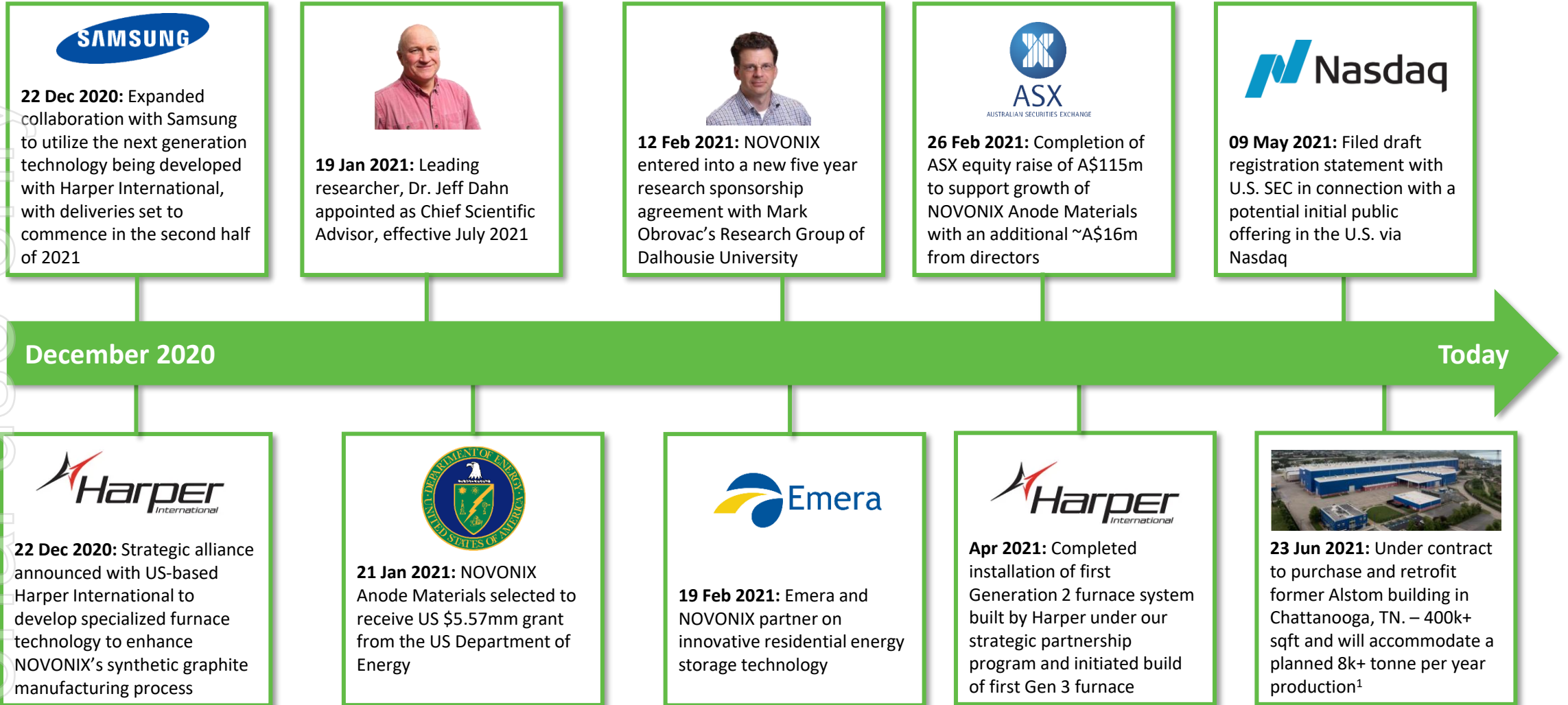

1. Purchase completed on July 28, 2021

# Corporate Activities (1 of 2)

## April – June 2021

- Zacks SCR initiated research coverage on NVN XF – 16 April 2021
- Shareholders approved AUD \$16.45M placement to Directors of NOVONIX – 27 April 2021
- Announced NOVONIX is exploring secondary trading of its securities on the Nasdaq – 10 May 2021
- Released updated company presentation – 2 June 2021
- Appointed Chris Hay as an alternate director to Trevor St. Baker AO – 17 June 2021
- Announced expansion of NOVONIX Anode Materials business with plans to purchase 400,000+ square-foot plant in Chattanooga, TN – 23 June 2021
- Management initiated a strategic review of the Mt. Dromedary high grade graphite deposit asset located in Northern Queensland, Australia
- Cash balance as of 30 June 2021: \$136.6 million

## Agreement with Battery Makers



SANYO Electric Co., Ltd. a subsidiary of Panasonic Corporation of Japan

# Corporate Activities (2 of 2)

## Post-June Quarter and Ongoing:

- Post-June Quarter:

- Prof. Jeff Dahn joined NOVONIX team as Chief Scientific Advisor – 1 July 2021
- Joined Battery Materials Technology Coalition to advocate for development of the US LIB supply chain – 7 July 2021
- Corporate Connect Research initiated research coverage on NVX – 26 July 2021
- Presenting at Sharecafe Webinar – 30 July 2021

- NOVONIX continues to:

- Monitor clean energy policies in North America and Europe and liaise with relevant agencies
- Provide samples of anode product and engage in discussion of qualification requirements and production capacity planning with prospective cell manufacturer and automotive OEM customers
- Engage and progress relationships with multiple international partners for potential technology partnership opportunities
- Leverage NOVONIX Battery Technology Solutions' (BTS) position in the market to identify strategic partnership opportunities for new technology development with new and existing customers



# NOVONIX Anode Materials Activities

April – June 2021

- Closed on new anode materials facility in Chattanooga, TN and awarded incentive packages related to hiring, power consumption and capital investment [Post-June Quarter]
- Furnace Systems and Production Capacity:
  - Optimizing production of material through Generation 2 system to support next steps in customer qualification programs
    - Scheduling upcoming shipments to Samsung SDI for qualification program
    - First mass production materials from Generation 2 have been shipped to Sanyo for qualification
  - Began facility preparations for first Generation 3 furnace system to be installed in Tennessee before the end of calendar year
  - Continued ordering additional necessary equipment to meet ongoing production targets
- Significant progress on Big Blue engineering for process optimization to maximize facility throughput
  - Continued process technology development and partnership discussions with equipment and material suppliers
- Progressed additional customer relationships with strong growing demand in the United States for local supply of synthetic graphite

# Battery Technology Solutions (BTS) Activities

April – June 2021

- Continued strong revenue growth and expansion of hardware sales and R&D service offerings
- Completing ~8,800 sq ft building addition to current facility for cell assembly and testing [Post-June Quarter]
- Closed on new ~35,000 sq ft facility in Halifax area and started facility renovations to move in before the end of this calendar year
- Received approval for up to CA\$1,281,819 through a payroll rebate from Nova Scotia Business Inc over 5 years to support hiring plans across the business
- Cathode/DPMG Commercialization Activities:
  - Expanding internal cathode development team and capabilities
  - Continued process development internally and collaboratively with Dr. Obrovac's group at Dalhousie pursuing new IP
  - Equipment ordering started for 10 tonne per annum capable demonstration line to be installed in new BTS facility in 2022
  - Received approval for \$475,000 grant from NRC-IRAP to support expansion of cathode development team [Post-June Quarter]
  - Other funding opportunities initiated to support scale up for cathode commercialization program



# Cathode/DPMG Commercialization Plan

## Current Funding



- NOVONIX is funding \$8.5 million for DPMG commercialization:
  - \$3.5 million for integration / deployment of DPMG technology into NOVONIX's cathode materials, driving higher yield, less waste, higher performance and higher margins
  - \$5.0 million for commercialization of DPMG technology to make high-performance long-life cathode materials including comprehensive testing at pilot scale and development of full-scale processing capability

## Current Status



- Pilot scale demonstration
- Optimizing conditions for different particles:
  - High nickel and cobalt free materials
  - Coatings / dopants for performance improvement
- Continuing to file new patents on IP around DPMG inventions and findings

## Next Steps



- Collaboration with technology partners and customers as well as evaluation of commercialization options including licensing, partnering and greenfield development
- 10 tonne per year capable demonstration line by 2022

# DPMG: New Manufacturing Method for Anode and Cathode

With multiple patent applications filed, NOVONIX believes that its Dry Particle Microgranulation (DPMG) technology delivers higher yields at lower costs

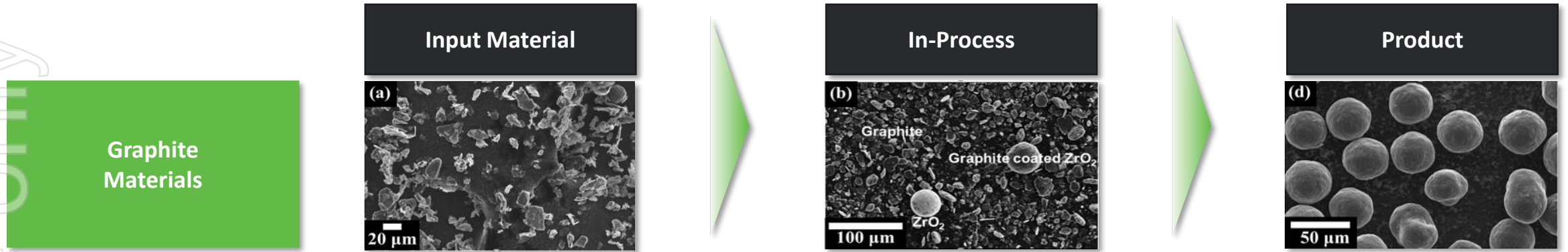

Higher Yield (recovery of waste fines to high value product) | Relatively lower cost | Flexible precursor inputs

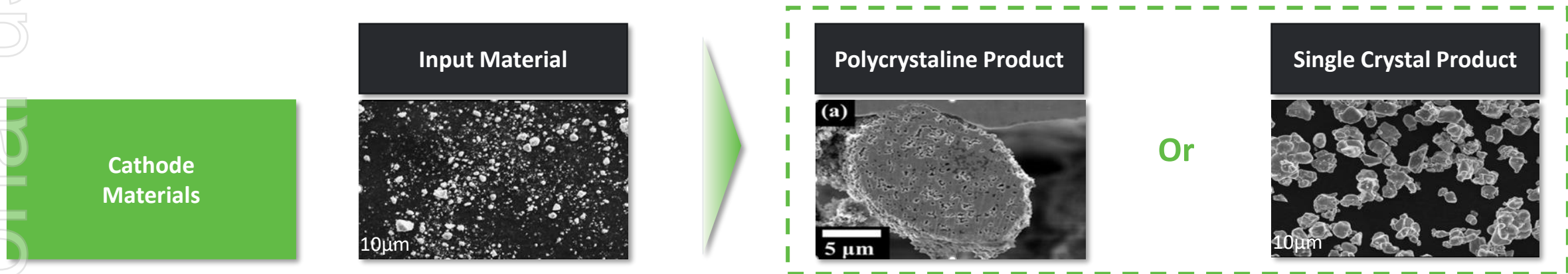

Higher Yield (recovery of waste fines to high value product) | No water waste | Relatively lower cost | High Nickel cathode materials

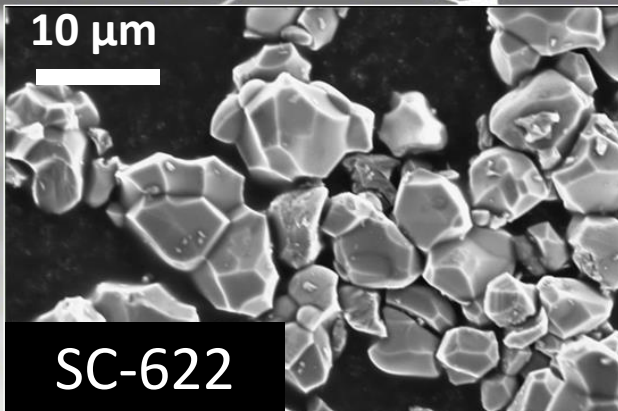
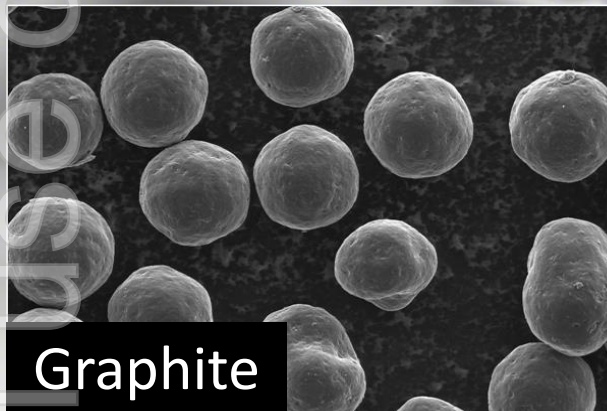

# Appendix

ersonal use only



# Our Leadership and Board of Directors

## Leadership Team



**Dr Chris Burns**  
Group CEO



**Nick Liveris**  
Group CFO



**Rashda Buttar**  
SVP & General Counsel



**Suzanne Yeates**  
Financial Controller & Co Secretary

## Technical Advisors



**Dr. Jeff Dahn**  
Chief Scientific Advisor



**Dr. Mark Obrovac**  
Sponsored Researcher

## Board of Directors



**Tony Bellas**  
Chairman & Non-Executive Director



**Greg Baynton**  
Non-Executive Director



**Robert Cooper**  
Non-Executive Director



**Andrew N. Liveris AO**  
Non-Executive Director



**Trevor St Baker AO**  
Non-Executive Director



**Admiral Robert J. Natter**  
Executive Director

Key leadership and technical experience:



# Prof. Jeff Dahn Joined NOVONIX – 1 July 2021

## Professor Jeff Dahn Overview

- Leading researcher in the field of lithium-ion batteries and materials
- Currently holds the title of NSERC/Tesla Canada Industrial Research Chair with Dalhousie University
- Long career across both industry and academia, and has spent the last 25 years as a professor at Dalhousie University, with support from 3M Company and most recently, from Tesla
- Co-authored 730 papers and has 73 inventions with patents issued or filed, including some of the early patents related to Li[NiMnCo]O<sub>2</sub> (NMC) cathode material in 2001



# NOVONIX Operations

## NOVONIX – BTS (HQ)

Bedford and Dartmouth, NS Canada  
Employees – 40 (as of June 30)



## Recent News

- New facility purchased in Chattanooga for the anode materials business; will accommodate planned 8,000+ tonne per year production
- New facility recently secured in Halifax dedicated to developing our cathode materials business
- BTS operating from 55,000+ sq ft in July 2021 in Bedford and Dartmouth, Nova Scotia
- NAM operating from 520,000+ sq ft in July 2021 in Chattanooga, TN
- Continued engineering and planning work for 30,000 tpa expansion plant to support 2025 NAM production expansion

## NOVONIX – Anode Materials

Chattanooga, TN USA  
Employees – 30 (as of June 30)



ASX: NVX

OTCQX: NVNXF



# NOVONIX Purchases “Big Blue” for Expansion



## Key Observations

- NOVONIX Anode Materials purchases the former Alstom building in Chattanooga, TN on July 28, 2021
- The 400,000+ square-foot plant will accommodate a planned 8,000+mtonne per year production to bring a total of 10,000 tonnes per year of synthetic graphite anode material in service by 2023
- The expansion is fully funded by cash on hand, underpinned by the equity raise on the ASX in February
- Expected to create 290 jobs and represents a potential investment up to \$160 million, which at the high end would include capacity above 8,000 tonnes of production
- TN Governor, Bill Lee, said “When companies like NOVONIX choose to expand in Tennessee, it underscores our state’s business-friendly environment, highly skilled workforce, and reputation for automotive strength. This project and the creation of nearly 300 new jobs will have a lasting impact on the Chattanooga community and Tennessee's economy.”



# Phased Growth Plan For NOVONIX Anode Materials

Volume /  
tonnage phased  
growth

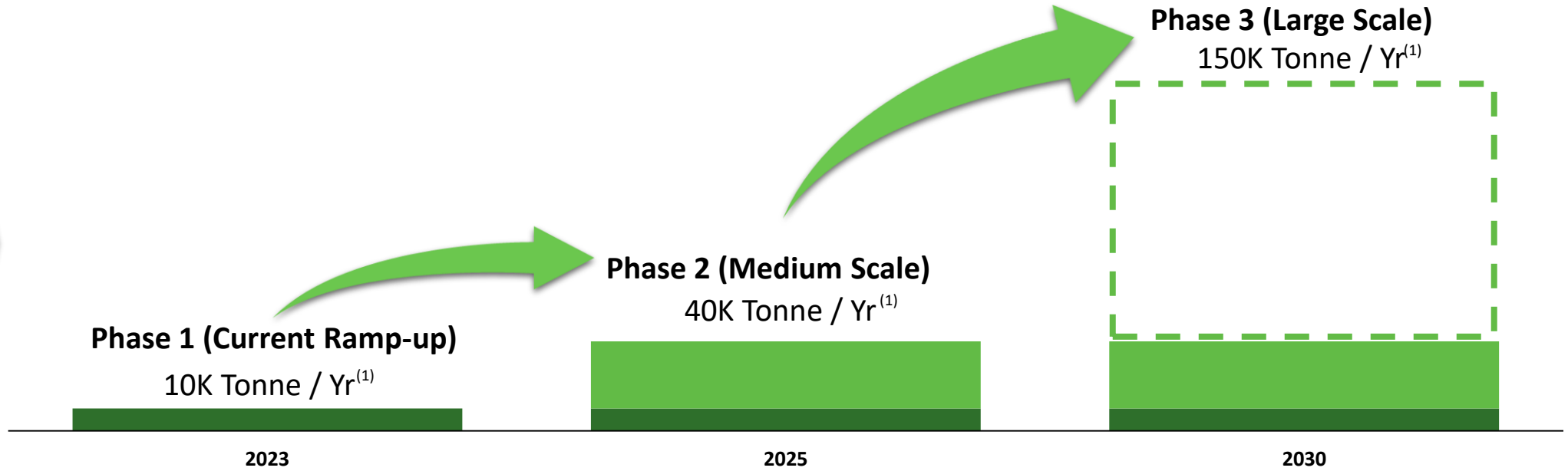

NOVONIX's  
illustrative  
scale plan<sup>(2)</sup>



(1) Company expectations, which may or may not materialize. (2) Assumes 55kg of graphite per EV.

# NOVONIX is Critical to Advancing the North American Electrification Story and Supply Chain

## Implied North America Graphite Anode Demand (Kt)

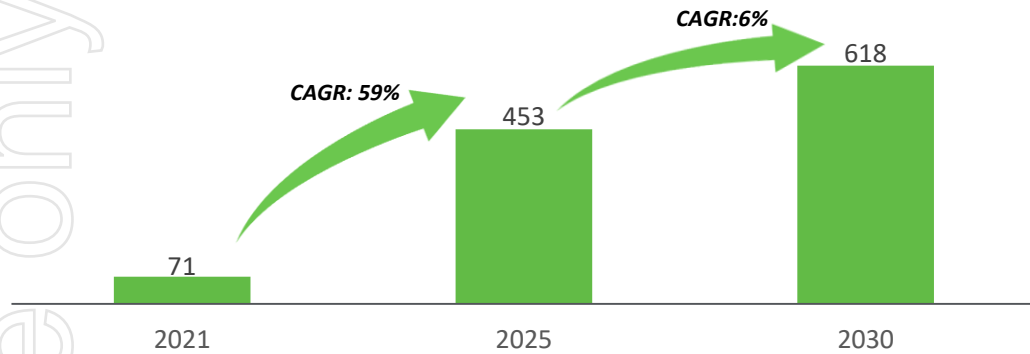

## Implied North America Cathode Material Demand<sup>1</sup> (Kt)

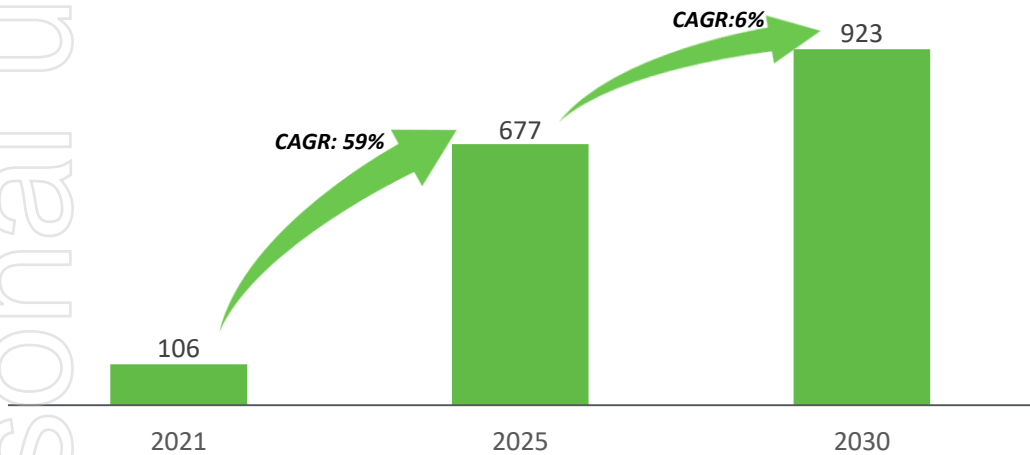

Source: Company press releases and management analysis.  
(1) Based on NCM 811 chemistry. (2) Expected capacity by 2028.

## Gigafactory Capacity Increasing to Support North American EV Growth

Battery Manufacturer	Auto OEM	Investment	2025E Capacity	Status	State
LG Chem		\$300M	16 GWh	Operating	MI
Panasonic SANYO		NA	53 GWh	Operating	NV
Envision AESC		NA	10 GWh	Operating	TN
LG Chem		\$2.3B	15 GWh	Announced Dec 2019	OH
		\$1B	95 GWh	Operating 2021	TX
		\$1.7B	10 GWh	Operating 2022	GA
LION ELECTRIC	LION ELECTRIC	\$185M	5 GWh	Operating 2022	QC (Canada)
iM3NY	NA	NA	32 GWh <sup>(2)</sup>	Operating 2022	NY
LG Chem		\$2.3B	35 GWh	Operating 2023	TN
		~\$0.8B	12 GWh	Operating 2023	GA
(BlueOvalSK JV)		NA	60 GWh	MoU signed May 2021	TBA (U.S.)

# NOVONIX's Technology is a Green Choice

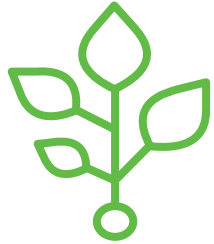

## Inputs

- Clean sources<sup>1</sup>
  - Carbon free resources represent 59% energy input
  - Renewables represent 16% energy input
- Circular use of oil-gas by-products and carbon offsetting

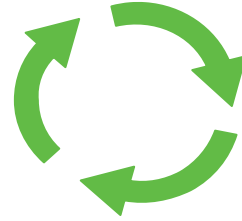

## Process

- Proprietary technology means fewer processing steps and less energy consumption
- No chemical purification



## Outputs

- Negligible emissions, less than alternatives
- Longer lasting batteries

1. FY2020 figures from Tennessee Valley Authority website.

# V2G is Expected to Further Drive Demand for High Battery Cycle Life

## Vehicle to Grid Provides Two Key Advantages



Enables fleets and individuals to reduce cost of ownership by charging at non-peak times and discharging to buildings or selling to grid at peak times



Ability to provide power to buildings or national grids during peak hours provides stability to grids

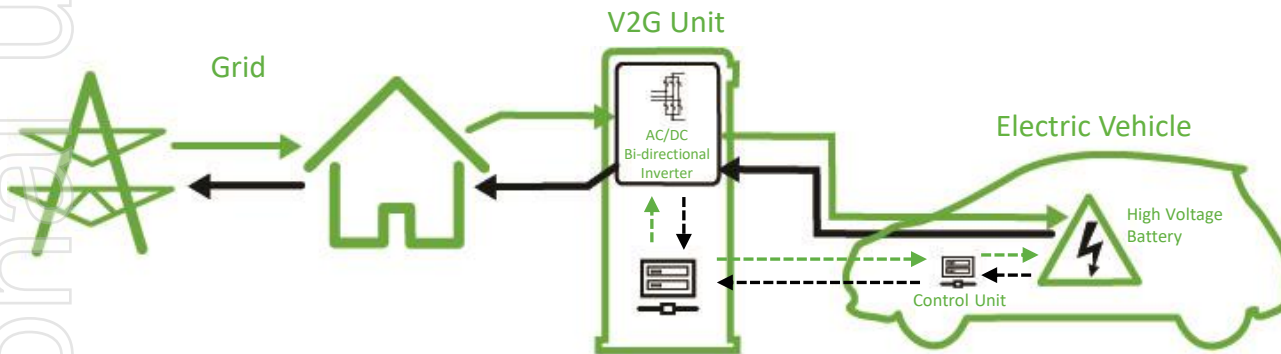

## Several Key EV OEMs Have Announced V2G Plans



- All VW MEB-based electric cars will be V2G capable beginning in 2022, includes cars from Audi, Skoda, and Seat-Cupra
- Currently testing DC-Wallbox with bi-directional DC charging stations in Germany



- Integrating vehicle-to-grid technology in electrical architecture of Model 3
- Tesla's system could power up to 22kW at any one moment – more than enough to power the dryer, heater or A/C.



- Currently conducting V2G project "i-rEzEPT", utilizing Nissan LEAF and temporary storage systems to power homes
- Produces the Nissan Leaf, the only mass production EV on the market with bi-directional capability



- 2022 F-150 Lightning will be one of the first EV's to take advantage of bi-directional charging in the U.S. market
- The Lightning will offer a solar option that will provide more energy independence and grid contribution

Source: CleanTechnica, The Driven, and Bloomberg.

# Contact Information

## Corporate

- **Chairman:**  
**Tony Bellas**  
Email: [tony@novonixgroup.com](mailto:tony@novonixgroup.com)
- **Company Secretary and Financial Controller:**  
**Suzanne Yeates**  
Email: [suzie@novonixgroup.com](mailto:suzie@novonixgroup.com)
- **Group CEO:**  
**Dr Chris Burns**  
Email: [chris@novonixgroup.com](mailto:chris@novonixgroup.com)
- **Group CFO:**  
**Nick Liveris**  
Email: [nick@novonixgroup.com](mailto:nick@novonixgroup.com)

Send all investor queries to:  
[IR@novonixgroup.com](mailto:IR@novonixgroup.com)

## Operations

### NOVONIX BTS:

177 Bluewater Road, Bedford, NS B4B 1H1, Canada  
110 Simmonds Drive, Dartmouth, NS B3B 1N9, Canada



### NOVONIX Anode Materials:

353 Corporate Place, Chattanooga, TN, 37419, USA  
1029 West 19<sup>th</sup> Street, Chattanooga, TN, 37408, USA



This announcement has been authorised for release to the ASX by the Chairman, Tony Bellas.